

Article number: 604132026020

Description: Taper bored timing belt pulley
HTD 26 8M 20 TL 1108

Measures

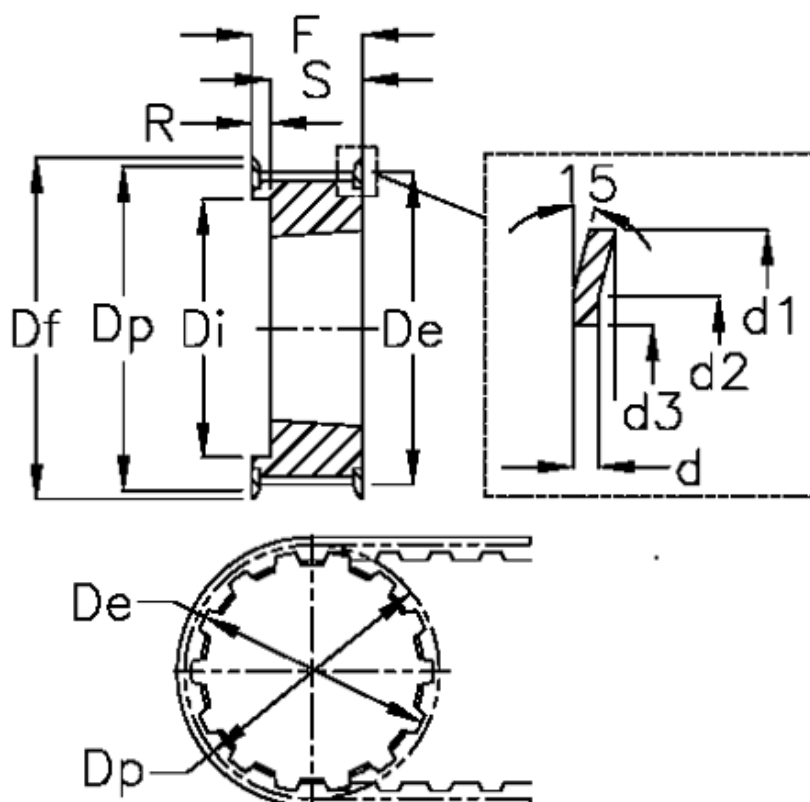

d = 1.5	F = 28	Weight = 0.36
d1 = 70	Flange type = F26	Width = 20
d2 = 66.5	For bushing = 1108	
d3 = 53	Max bore = 25	
De = 64.84	r = 6	
Df = 70	S = 22	
Di = 45	Tooth number = 26	
Dp = 66.21	Type = 8M	